



DentaDrive 120V S21

High Frequency Spindle

Electric Direct Tool Change

Identification of HF spindle

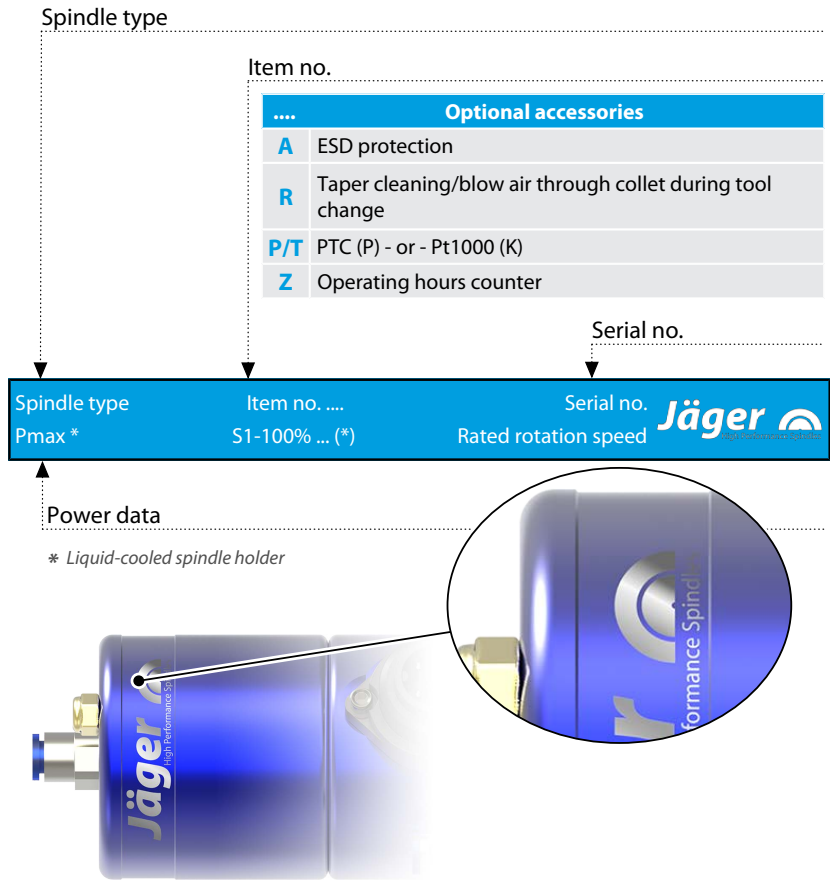

As we always ensure that our HF spindles are at the cutting edge of technological development, we reserve the right to make technical modifications and variations from the exact design described in the manual.

The text in this manual has been compiled with the utmost care. However, **Nakanishi Jaeger GmbH** cannot assume any legal responsibility or liability of any kind for incorrect information and any consequences thereof.

Translations and reproductions – including of extracts – are prohibited without the express written approval of **Nakanishi Jaeger GmbH**.



Contents:

Translation of the original manual

1	Preliminary information	5	6.6	Motor protection PTC 100°C (optional accessory)	29
1.1	Purpose of the manual	5	6.7	ESD protection (optional accessory)	29
1.2	Explanation of symbols used	5	6.8	Air-borne noise emissions	30
2	Transport and packaging	6	7	Operating location	30
2.1	Scope of supply of HF spindle	6	8	Installation	31
2.1.1	Service set	6	8.1	Installing the HF spindle	31
2.1.2	Optional accessories	7	8.2	Diameter of media supply line	31
2.1.3	Documentation supplied	7	8.3	Compressed air	32
2.2	Packaging of HF spindle	7	8.3.1	Air purity classes (ISO 8573-1)	32
3	Designated use	8	8.3.2	Setting the sealing air	32
3.1	Permissible types of machining	8	8.3.3	Setting values	33
3.2	Permissible materials	8	9	Commissioning	34
4	Safety instructions	9	9.1	Running-in schedule	34
4.1	Safe working	10	9.2	Daily start-up	35
4.2	Shutdown of HF spindle	11	9.3	Shutdown signal	35
4.3	Installation and maintenance	11	9.4	Commissioning after storage	35
4.4	Modification and repair	11	10	Tool change	36
4.5	Improper operation	11	10.1	Clockwise	36
5	Technical description	12	10.2	Electric Direct Tool Change	36
5.1	Connections of HF spindle	12	10.2.1	Connection example	37
5.2	Electrical connection	13	10.2.2	Changing the collet	38
5.3	Cooling	14	10.3	Tool changing station (optional accessory)	39
5.3.1	Cooling via spindle holder	14	10.3.1	Electric Direct Tool Change	39
5.4	Sealing air	15	10.3.2	Installing the changing station	39
5.5	Taper cleaning (optional accessory)	15	10.3.3	Maintenance	39
5.6	Electrical tool change	15	11	Tools for high speed cutting	40
6	Technical Specifications	16	11.1	Broken-off tool	40
6.1	Dimensions	17	12	Maintenance	41
6.2	Motor data	18	12.1	Ball bearings	41
6.2.1	Performance Diagram	19	12.2	Daily cleaning	41
6.2.2	Equivalent circuit diagram data	19	12.2.1	Before commencing work	41
6.3	Motor data	22	12.2.2	With every tool change	41
6.3.1	Performance Diagram	23	12.2.3	Every time the clamping device is changed	42
6.3.2	Equivalent circuit diagram data	24	12.3	In the case of storage	42
	Leerzeile	25	12.4	Monthly maintenance	42
6.4	Wiring diagram	26			
6.5	Motor protection Pt1000 (optional accessory)	28			



Contents:

Translation of the original manual

12.5	Long periods of storage	42
12.6	Maximum storage time	42
13	Dismantling	43
13.1	Disposal and environmental protection	43
14	Service and repairs	43
14.1	Service partners.....	43
14.2	Malfunctions.....	44
15	Declaration of Incorporation	47

1 Preliminary information

The high frequency spindle (HF spindle) is a high quality precision tool for high speed machining.

1.1 Purpose of the manual

The manual is an important component of the HF spindle.

- ➔ Store the manual carefully.
- ➔ Make the manual available to all persons who work with the HF spindle.
- ➔ Read the documentation supplied in full.
- ➔ Before carrying out any work, read the corresponding section of the manual carefully again.

1.2 Explanation of symbols used

To enable quick classification of information, this manual uses visual aids in the form of symbols and text markings.

Notes are marked with a signal word and a colored box:



DANGER

Dangerous situation!

Results in serious injury or death.

- ▶ Measure to avert the danger.



WARNING

Dangerous situation!

May result in serious injury or death.

- ▶ Measure to avert the danger.



CAUTION

Dangerous situation!

May result in minor to moderate injury.

- ▶ Measure to avert the danger.



Note

May result in material damage. This warning symbol is not a warning for personal injury.

Tip

Tips indicate useful information for users.

2



Example of design: Inserting the shank

Transport and packaging

Note: Ensure functionality

- ▶ When transporting the HF spindle, always fit an appropriate shank in the collet.

Avoid strong vibrations or impacts during transportation, as these could damage the ball bearings of the HF spindle.

- Any damage reduces the accuracy of the HF spindle.
- Any damage restricts the functionality of the HF spindle.
- Any damage shortens the service life of the HF spindle.

2.1

Scope of supply of HF spindle

The following parts are supplied with the HF spindle:

- High Frequency Spindle
- Service set
- Hose connections
- Transport packaging
- Check the high frequency spindle for completeness upon delivery.

2.1.1

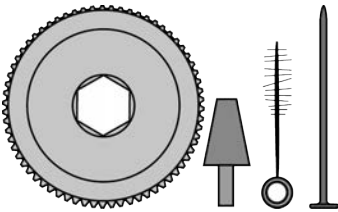

Service set

- Collet grease
- Ejector pin
- Collet screw-in tool
- Felt cleaning taper
- Cylinder brush with eyelet

2.1.2 Optional accessories

Available on request:

- Spindle holder
- Frequency converter
- Collet
- Motor cable
- Operating hours counter
- ESD protection
- Motor protection (PTC or Pt1000)
- Further accessories on request.

Only approved accessories have been tested for operational safety and functionality.

- ➔ Do not use any other accessories – this may invalidate any warranty claims and compensation claims for damages.
- ➔ If the spindle holder is to be produced in-house, it is essential to contact **Nakanishi Jaeger GmbH** before starting production to request the tolerances and production plan for the spindle holder.

2.1.3 Documentation supplied

The documents listed below are supplied with the HF spindle:

- Manual
- The declaration of incorporation is part of the manual.
- Inspection protocol
- ➔ Check that the documentation supplied is complete when the spindle is delivered. If necessary, request a new copy.

2.2 Packaging of HF spindle



All transport packaging materials can be recycled in appropriate disposal facilities.

3 Designated use

The HF spindle is an “incomplete machine” in accordance with the Machinery Directive and cannot perform any function independently. The HF spindle can only be operated in conjunction with a machine tool and a frequency converter.

3.1 Permissible types of machining

The HF spindle has been developed only for the following types of machining.

- Cutting
- Drilling
- Engraving
- Grinding
- ➔ Contact **Nakanishi Jaeger GmbH** if other types of machining are required.

3.2 Permissible materials

The HF spindle has been developed only for the following materials.

- Metals (such as alloys, cast metals etc.)
- Sintered materials
- Plastics
- Wood
- Graphite
- Stone (marble, etc.)
- Paper and cardboard
- Circuit boards
- Glass and ceramic
- ➔ Contact **Nakanishi Jaeger GmbH** if other materials are to be machined.

4 Safety instructions

The high frequency spindle is a state of the art product and is safe to operate.

However, the HF spindle may pose a risk in the following cases:

- If it is installed by untrained personnel.
- If it is used incorrectly.
- If it is not used in accordance with its intended use.

The high frequency spindle may only be installed, commissioned, and maintained by specialist personnel.

Definition: Specialist personnel are persons who are familiar with the assembly, installation, commissioning, and operation of the product and have the relevant qualifications for their area of activity. The operator must closely control the responsibility, training, and monitoring of these personnel.



DANGER: Due to explosion.

HF spindles are not approved for use in areas at risk of explosion. Use in such areas may result in explosions.

- ▶ Do not use the HF spindle in potentially explosive atmospheres.



DANGER: Due to flying parts.

The HF spindle operates at high speeds and may therefore be flung away by these.

- ▶ Operate the HF spindle only if it is installed in the machine or system in a fixed manner.



Note: Adhere to the limit values.

- ▶ Observe the limit values specified in the technical data.



Note: Take account of the machine.

- ▶ Observe the manual of the machine in which the HF spindle is installed.
- ▶ Observe all safety instructions specified by the machine manufacturer.
- ▶ Ensure that the machine does not cause any hazards (e.g. uncontrolled movements). Do not install the HF spindle in the machine until this has been done.



Note. Do not damage the HF spindle.

- ▶ Any damage reduces the accuracy of the HF spindle.
- ▶ Any damage restricts the functionality of the HF spindle.
- ▶ Any damage shortens the service life of the HF spindle.

4.1

Safe working

Observe all safety instructions set out in the manual, the applicable national accident prevention regulations, and the valid company work, operation, and safety guidelines.



DANGER: Due to flying parts.

Tools that are not clamped correctly will be flung away by the centrifugal forces that occur during machining.

- ▶ Use the full clamping depth of the collet.
- ▶ Clamp the tool securely.



DANGER: Due to flying parts.

If the wrong rotational direction is used, the clamping system releases and the tool is flung away.

- ▶ It is essential to adhere to the rotational direction of the HF spindle.



WARNING: Risk of injury due to flying parts.

The HF spindle operates at high speeds which may cause chips to fly out with great force.

- ▶ Never remove the protective devices of the machine or system.
- ▶ Always wear protective goggles during work.

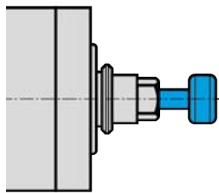

Example of design: Inserting the shank

Note: Ensure functionality.

- ▶ Never operate the HF spindle without a clamped tool shank.

If no tool shank is clamped:

- The clamping system is damaged by the centrifugal forces.
- The clamping system is shifted.
- The balance of the HF spindle is affected.
- The bearing is damaged.

- ➔ Take the relevant measures to protect against splashes and spray according to the type of machining, the type of material being machined, and the type of tool selected.
 - ↳ Observe the manual of the machine in which the HF spindle is installed.
- ➔ Obtain the maximum circumferential speeds of the tools used from the tool supplier.

Single-point tools are not suitable for high speed cutting.

If they are required for production reasons:

- ➔ Only use a balanced tool.
 - ↳ DIN ISO 1940
 - ↳ Balance grade 2,5

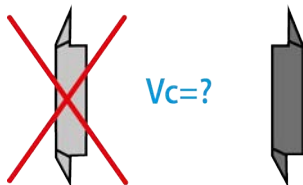

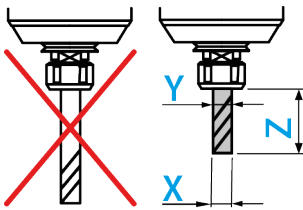

The tool cutting diameter (X) must not be greater than the maximum clamping range (Y).

- ➔ Always clamp the tool so that it is as short as possible.
- ➔ Keep the dimension (Z) small.
- ➔ (Y) See section: Technical Specifications [▶ 16].

4.2

Shutdown of HF spindle

The procedure for shutting down the high frequency spindle for installation and maintenance work is as follows:

- ➔ Completely disconnect the power supply.
- ➔ Completely disconnect the media supply (air and liquid).
- ➔ Make sure that the shaft of the HF spindle has come to an absolute standstill.

If the HF spindle is being shut down to be cleaned:

- ➔ Reconnect only the sealing air.

Tip: Forward the data to the controller.

- ▶ Use the option on the frequency converter of detecting the shutdown signal from the shaft and forwarding this to the machine controller for evaluation.

4.3

Installation and maintenance

- ➔ Carry out installation, cleaning, and maintenance work only after shutting down the HF spindle and after the shaft has come to a standstill.
- ➔ Install all safety and protective devices of the machine immediately after completing work.

4.4

Modification and repair

Modifications or alterations to the HF spindle are only permitted after prior consultation with **Nakanishi Jaeger GmbH**.

Only the service partners listed in the "Service and repair [▶ 43]" section are authorized to open and repair the HF spindle.

Only approved accessories have been tested for operational safety and functionality.

4.5

Improper operation

The high frequency spindle is only safe to operate for its designated use.

- ➔ Observe the safety instructions in all sections of the manual to prevent hazards to persons, the environment, the machine, or the HF spindle itself.

Failure to observe the safety instructions may invalidate any warranty claims and compensation claims for damages.

5 Technical description

5.1 Connections of HF spindle

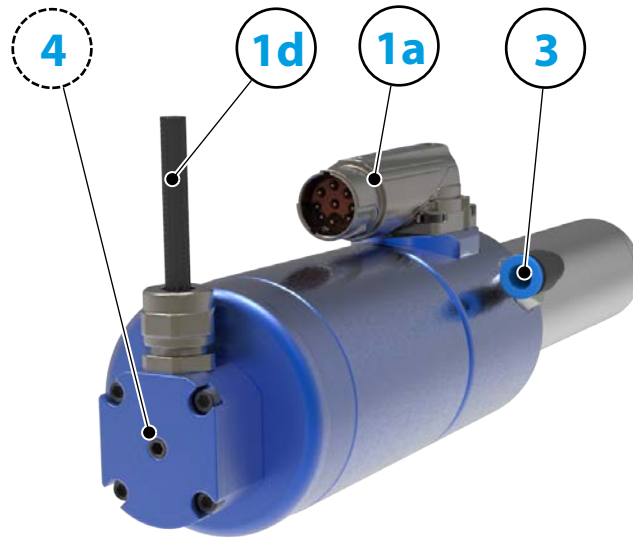

1a	Electrical connection for: motor phases	
1d	Electrical connection for: Tool change	
3	Sealing air	G 1/8"
4	Taper cleaning (optional accessory)	M5

5.2 Electrical connection

The HF spindle may only be operated with a frequency converter (FC).

- ➔ Check whether the current, voltage, and frequency data of the HF spindle match the raw data for the frequency converter.
- ➔ Use a motor supply line that is as short as possible.
- ➔ Adjust the speed of the HF spindle using the FC.
- ➔ Refer to the frequency converter manual for further information.

The FC detects the following operating states of the HF spindle, depending on the version:

- HF spindle rotating.
- HF spindle too hot.
- HF spindle at a standstill, etc.

The FC forwards the operating states of the HF spindle to the machine controller.

5.3

Cooling

The HF spindle does not feature built-in cooling. However, this means that it has a lower power than an HF spindle with cooling.



Note: Ensure functionality.

The HF spindle is cooled by the sealing air flowing through.

- Always switch on the sealing air as soon as the machine enters operation.
- Sealing air temperature: max. 25°C.

If this is not observed, the HF spindle will be damaged or destroyed.

Note: Extension of the service life through heat dissipation.

Heat is produced during operation of the HF spindle. The temperature of the HF spindle should not exceed + 45° C as this shortens the service life of the bearing.

- ▶ Check the temperature of the HF spindle on the housing.
- ▶ Dissipate the heat using the spindle holder.

5.3.1

Cooling via spindle holder

To increase the power of the HF spindle, the heat generated must be dissipated via the spindle holder (optional accessory).

If the spindle holder is to be produced in-house:

- ➔ Contact **Nakanishi Jaeger GmbH**.
- ➔ Request the tolerances and production plan for the spindle holder.
- ➔ Produce the spindle holder from a thermally-conductive material (e.g. aluminum).
- ➔ Observe the dimensions of the clamping range in the Technical Specifications [▶ 16] section. Make sure that the HF spindle is enclosed by the spindle holder to the specified length.
- ➔ Add cooling fins or holes (greater heat dissipation) to the external surface of the spindle holder.

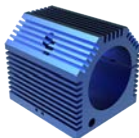

Example of design:
Air-cooled spindle holder

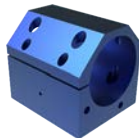

Example of design:
Liquid-cooled spindle holder

5.4

For guidelines on air quality, see "Air purity classes (ISO 8573-1) [▶ 32]" section.

Sealing air

The sealing air prevents foreign bodies such as chips and liquids (e.g. emulsions) from entering the HF spindle.

- ➔ Check that air escapes at the front between the housing and the rotating parts of the HF spindle.

5.5

Taper cleaning (optional accessory)

Taper cleaning prevents chips and liquids from entering the shaft during a tool change and causing contamination and damage to the inner taper and the clamping system.



Note: Ensure functionality.

- Only switch on taper cleaning in conjunction with electromagnetic tool change.

If this is not done, the HF spindle will be damaged or destroyed.

5.6

Electrical tool change

The tool change or tool taper change is performed electrically.

During this, a mechanism is operated inside the HF spindle which clamps, releases, or ejects the tool taper or collet.

6

Technical Specifications

Bearings

Hybrid ball bearing (pcs)	2
Lifetime lubricated	maintenance free

Power values

Compressed air cooled

	Pmax./5s	S6-60%	S1-100%	
Rated power	0,25	0,24	0,2	[kW]
Torque	0,039	0,038	0,033	[Nm]
Voltage	32	32	32	[V]
Current	8,2	7,7	6,9	[A]

Power values

Spindle holder cooled

	Pmax./5s	S6-60%	S1-100%	
Rated power	0,32	0,31	0,3	[kW]
Torque	0,065	0,063	0,061	[Nm]
Voltage	34	34	34	[V]
Current	10	9,8	9,5	[A]

Motor data

Motor technology	3-phase asynchronous drive (no brushes or sensors)
Frequency	2.000 Hz
Motor poles (pairs)	1
Rated rotation speed	120.000 rpm
Acceleration/braking value Per second	10 000 rpm (other values by consultation)

Electromagnetic cylinder

Pulse duration	< 0.2 sec
Voltage	48 V _{DC}
Current	10 A
Release force	> 2000 N

Characteristics

Motor protection	PTC 100°C or Pt1000 Optional accessory
Housing	Stainless steel
Housing diameter	33 mm
Cooling	Compressed air cooled
Heat dissipation	Via the spindle holder
Housing temperature	< + 45° C
Ambient temperature	+ 10°C ... + 45°C
Sealing air	
Protection category (sealing air turned on)	IP54
Taper cleaning	Optional accessories
ESD protection	Optional accessories
Tool change	Electric Direct Tool Change
Collet type	5,1P-5° Optional accessories
Clamping range up to	3.5 mm (1/8")
Clockwise	
Coupler plug	9-pin (I-TEC)
Weight	~ 0,9 kg
Inner taper run out	< 1 μ

6.1 Dimensions

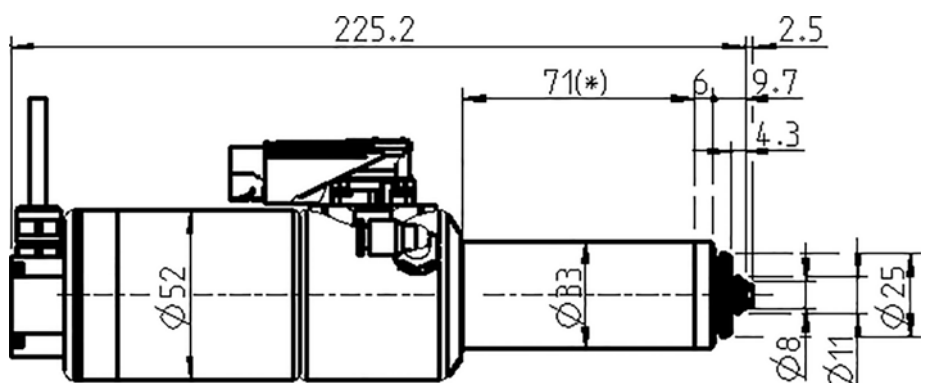

(*) = Clamping range

6.2

The power values (S1, S6, S2) are valid for sinusoidal currents and voltages.

The power values of the HF spindle are dependent on the frequency converter used and may vary from the indicated values.

Motor data

Spindle characteristic curve	KL 1028
Motor technology	AC Motor
Motor type	ACM 26/15/30-2E
Rated power	0,3 kW
Rated rotation speed	120.000 rpm
Cooling	Spindle holder cooled (liquid-cooled spindle holder)
Motor protection	PTC 100°C or Pt1000 Optional accessory
Winding resistance (phase-phase)	0,4 Ω
Power dissipation	122 W – max. (S1)

Measured values: S1-100%

Rated rotation speed	10 000	30 000	40 000	50 000	60 000	80 000	90 000	100 000	110 000	120 000	rpm
Speed	8 220	27 550	37 570	47 549	56 722	75 328	85 111	95 001	105 240	115 287	rpm
Frequency	167	500	667	833	1 000	1 333	1 500	1 667	1 833	2 000	Hz
Rated power	0,041	0,177	0,234	0,291	0,303	0,293	0,272	0,249	0,211	0,182	kW
Torque	0,047	0,061	0,059	0,058	0,051	0,037	0,031	0,025	0,023	0,019	Nm
Voltage	10	23	28	34	34	34	34	34	34	34	V
Current	8	9,5	9,5	9,5	9,5	9,5	9	8,5	8	7,5	A
cos φ	0,91	0,86	0,84	0,83	0,85	0,86	0,86	0,86	0,87	0,87	

Measured values: S6-60%

Rated rotation speed	10 000	30 000	40 000	50 000	60 000	80 000	90 000	100 000	110 000	120 000	rpm
Speed	8 070	27 418	37 463	47 430	56 609	75 160	84 766	94 609	104 790	114 828	rpm
Frequency	167	500	667	833	1 000	1 333	1 500	1 667	1 833	2 000	Hz
Rated power	0,043	0,182	0,242	0,301	0,312	0,301	0,283	0,261	0,222	0,193	kW
Torque	0,051	0,063	0,062	0,061	0,053	0,038	0,032	0,026	0,024	0,02	Nm
Voltage	10	23	28	34	34	34	34	34	34	34	V
Current	8,4	9,8	9,8	9,8	9,8	9,8	9,5	9	8,5	8	A
cos φ	0,91	0,87	0,84	0,84	0,86	0,86	0,86	0,86	0,87	0,87	

Measured values: S2-Pmax./5 s

Rated rotation speed	10 000	30 000	40 000	50 000	60 000	80 000	90 000	100 000	110 000	120 000	rpm
Speed	7 996	27 362	37 545	47 449	56 756	75 402	84 552	94 158	104 523	114 093	rpm
Frequency	167	500	667	833	1 000	1 333	1 500	1 667	1 833	2 000	Hz
Rated power	0,043	0,186	0,249	0,310	0,321	0,309	0,296	0,272	0,233	0,214	kW
Torque	0,051	0,065	0,063	0,062	0,054	0,039	0,033	0,028	0,025	0,022	Nm
Voltage	11	23	28	34	34	34	34	34	34	34	V
Current	8,6	10	10	10	10	10	10	9,5	9	9	A
cos φ	0,91	0,88	0,85	0,84	0,86	0,86	0,86	0,87	0,87	0,87	

Note on operation with static frequency converters:

For operation with a frequency converter, the effective fundamental voltage must correspond to the specified motor voltage.

The measured currents may be greater than the specified values due to the harmonic content.

6.2.1 Performance Diagram

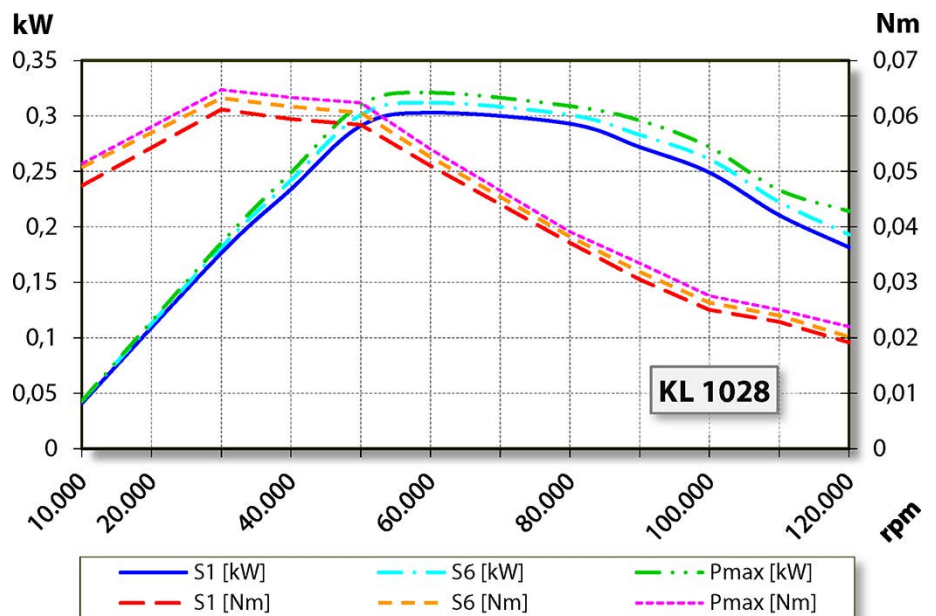

6.2.2 Equivalent circuit diagram data

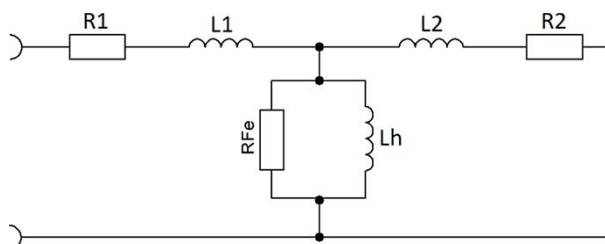



Note: Damage due to incorrect performance data.

The values of the parameters relate exclusively to the motor.

► HF spindle values: See tables S1-100%, S6-60% and S2-Pmax.

Parameter*	Meaning	Value	Unit
p0304	Rated voltage (phase-phase)	34	Vrms
p0305	Rated current	9,5	Arms
p0307	Rated power	0,332	kW
p0308	Rated power factor	0,81	cos φ
p0310	Rated frequency	1.000	Hz
p0311	Rated speed	56.461	rpm
---	Rated power loss	122	W
---	Rated rotation speed	120.000	rpm
p0312	Rated torque	0,056	Nm
p0314	Motor poles (pairs)	1	---
p0320	Rated magnetization current	3,74	Arms
p0322	Maximum speed	120.000	rpm
p0326	Stalling torque correction factor	100	%
p0335	Cooling type	Spindle holder cooled	
p0341	Moment of inertia	0,0000041	kgm ²
p0348	Field weakening operating speed VDC=600V	704.547	rpm
p0350	Stator resistance, cold (strand)	0,194	Ω
p0353	Series inductance (strand)	0	mH
p0354	Rotor resistance, cold	0,102	Ω
p0356	Stator stray inductance	0,043	mH
p0358	Rotor stray inductance	0,063	mH
p0360	Main inductance	0,696	mH
p0604	Motor temperature warning threshold	71	°C
p0605	Motor temperature fault threshold	100	°C
p0640	Current limit	10	Arms
p1800	Pulse frequency	16	kHz
---	DC link voltage	48	VDC
---	Series capacitance		μF
---	Maximum voltage		V
---	Idle reduction		%
---	Stator stray reactance X1	0,267	Ω
---	Rotor stray reactance X2	0,394	Ω
---	Main field reactance Xh	4,376	Ω

(*) Parameters for Siemens SINAMICS 120

Parameter	Meaning	Value	Unit
---	Desaturation speed **	115.000	rpm
---	Main inductance at maximum speed **	0,923	mH
---	Saturation factor **	1,881	%
---	Tilting torque reduction factor **	93,64	%

(**) Additional parameters Heidenhain

6.3

The power values (S1, S6, S2) are valid for sinusoidal currents and voltages.

The power values of the HF spindle are dependent on the frequency converter used and may vary from the indicated values.

Motor data

Spindle characteristic curve	KL 1023
Motor technology	AC Motor
Motor type	ACM 26/15/30-2E
Rated power	0,2 kW
Rated rotation speed	120.000 rpm
Cooling	Compressed air cooled
Motor protection	PTC 100°C or Pt1000 Optional accessory
Winding resistance (phase-phase)	0,4 Ω
Power dissipation	76 W – max. (S1)

Measured values: S1-100%

Rated rotation speed	10 000	20 000	30 000	40 000	50 000	60 000	70 000	80 000	90 000	100 000	120 000	rpm
Speed	8 148	18 072	28 158	38 103	48 026	57 949	67 400	77 049	86 698	96 644	116 800	rpm
Frequency	167	333	500	667	833	1 000	1 167	1 333	1 500	1 667	2 000	Hz
Rated power	0,028	0,061	0,092	0,123	0,153	0,184	0,204	0,189	0,175	0,153	0,108	kW
Torque	0,033	0,032	0,031	0,031	0,031	0,030	0,029	0,023	0,019	0,015	0,009	Nm
Voltage	9	14	18	23	27	32	33	32	32	32	32	V
Current	6,9	6,9	6,9	6,9	6,9	6,9	6,6	6,3	6	5,9	4,8	A
cos φ	0,89	0,84	0,79	0,77	0,77	0,78	0,86	0,88	0,9	0,9	0,82	

Measured values: S6-60%

Rated rotation speed	10 000	20 000	30 000	40 000	50 000	60 000	70 000	80 000	90 000	100 000	120 000	rpm
Speed	8 148	17 628	27 750	37 794	47 705	57 615	66 845	76 286	85 727	95 470	115 813	rpm
Frequency	167	333	500	667	833	1 000	1 167	1 333	1 500	1 667	2 000	Hz
Rated power	0,028	0,066	0,105	0,146	0,188	0,229	0,243	0,236	0,228	0,217	0,175	kW
Torque	0,033	0,036	0,036	0,037	0,038	0,038	0,035	0,029	0,025	0,022	0,014	Nm
Voltage	9	14	18	23	28	33	33	32	32	32	32	V
Current	6,9	7,7	7,7	7,7	7,7	7,7	7,5	7,4	7,2	6,8	6	A
cos φ	0,89	0,86	0,81	0,79	0,79	0,79	0,88	0,89	0,9	0,9	0,83	

Measured values: S2-Pmax./5 s

Rated rotation speed	10 000	20 000	30 000	40 000	50 000	60 000	70 000	80 000	90 000	100 000	120 000	rpm
Speed	8 148	17 836	27 523	37 616	47 571	57 526	66 811	76 263	85 714	95 201	114 123	rpm
Frequency	167	333	500	667	833	1 000	1 167	1 333	1 500	1 667	2 000	Hz
Rated power	0,028	0,066	0,108	0,153	0,195	0,237	0,253	0,241	0,229	0,220	0,179	kW
Torque	0,033	0,035	0,037	0,039	0,039	0,039	0,036	0,030	0,026	0,022	0,015	Nm
Voltage	9	14	18	23	28	33	33	32	32	32	32	V
Current	6,9	8,2	8,2	8,2	8,2	8,2	8,1	8,1	8,0	8	8	A
cos φ	0,89	0,87	0,82	0,81	0,8	0,8	0,89	0,9	0,91	0,91	0,83	

Note on operation with static frequency converters:

For operation with a frequency converter, the effective fundamental voltage must correspond to the specified motor voltage.

The measured currents may be greater than the specified values due to the harmonic content.

6.3.1 Performance Diagram

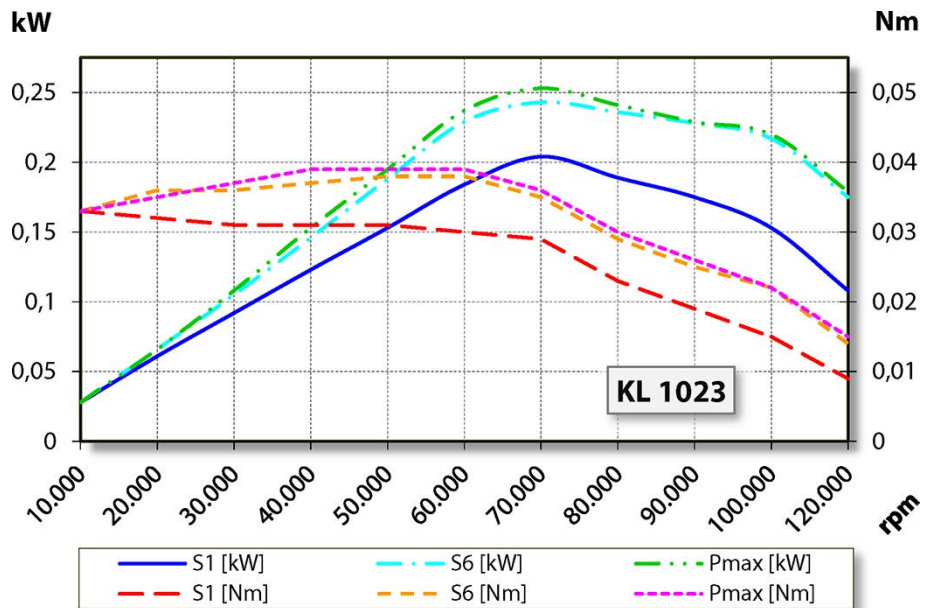

Note: Ensure functionality.

The HF spindle is cooled by the sealing air flowing through.

- Always switch on the sealing air as soon as the machine enters operation.
- Sealing air temperature: max. 25°C.

If this is not observed, the HF spindle will be damaged or destroyed.

6.3.2 Equivalent circuit diagram data

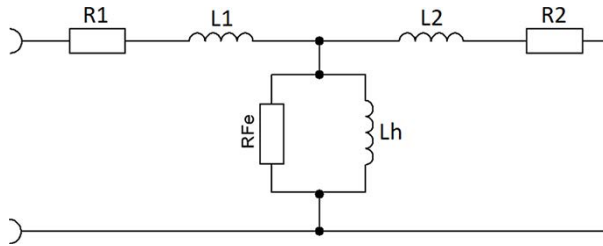

Note: Damage due to incorrect performance data.

The values of the parameters relate exclusively to the motor.

► HF spindle values: See tables S1-100%, S6-60% and S2-Pmax.

Parameter*	Meaning	Value	Unit
p0304	Rated voltage (phase-phase)	32	Vrms
p0305	Rated current	6,3	Arms
p0307	Rated power	0,188	kW
p0308	Rated power factor	0,74	cos φ
p0310	Rated frequency	1.000	Hz
p0311	Rated speed	57.949	rpm
---	Rated power loss	87	W
---	Rated rotation speed	120.000	rpm
p0312	Rated torque	0,031	Nm
p0314	Motor poles (pairs)	1	---
p0320	Rated magnetization current	3,4	Arms
p0322	Maximum speed	120.000	rpm
p0326	Stalling torque correction factor	100	%
p0335	Cooling type	Compressed air cooled	
p0341	Moment of inertia	0,0000041	kgm ²
p0348	Field weakening operating speed VDC=600V	768.303	rpm
p0350	Stator resistance, cold (strand)	0,194	Ω
p0353	Series inductance (strand)	0	mH
p0354	Rotor resistance, cold	0,102	Ω
p0356	Stator stray inductance	0,054	mH
p0358	Rotor stray inductance	0,076	mH
p0360	Main inductance	0,748	mH
p0604	Motor temperature warning threshold	60	°C
p0605	Motor temperature fault threshold	100	°C
p0640	Current limit	7,8	Arms
p1800	Pulse frequency	16	kHz
---	DC link voltage	48	VDC
---	Series capacitance		μF

Parameter*	Meaning	Value	Unit
---	Maximum voltage		V
---	Idle reduction		%
---	Stator stray reactance X1	0,34	Ω
---	Rotor stray reactance X2	0,476	Ω
---	Main field reactance Xh	4,702	Ω

(*) Parameters for Siemens SINAMICS 120

Parameter	Meaning	Value	Unit
---	Desaturation speed **	116.964	rpm
---	Main inductance at maximum speed **	0,923	mH
---	Saturation factor **	2,07	%
---	Tilting torque reduction factor **	72,88	%

(**) Additional parameters Heidenhain

6.4 Wiring diagram

Note: Do not change the ex-works configuration.

Any change may cause overvoltage on the electrical components (e.g. PTC, differential magneto resistor).

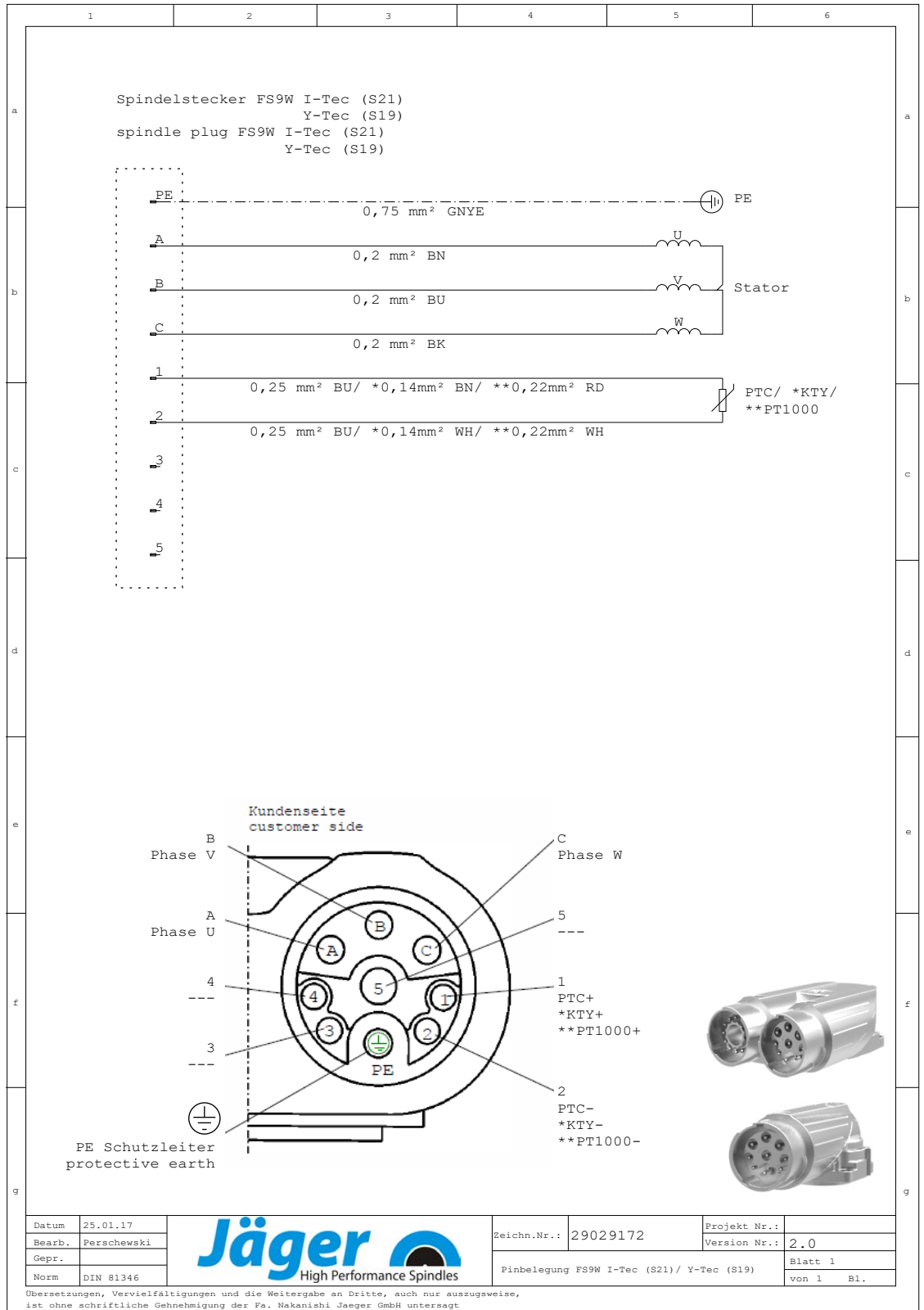

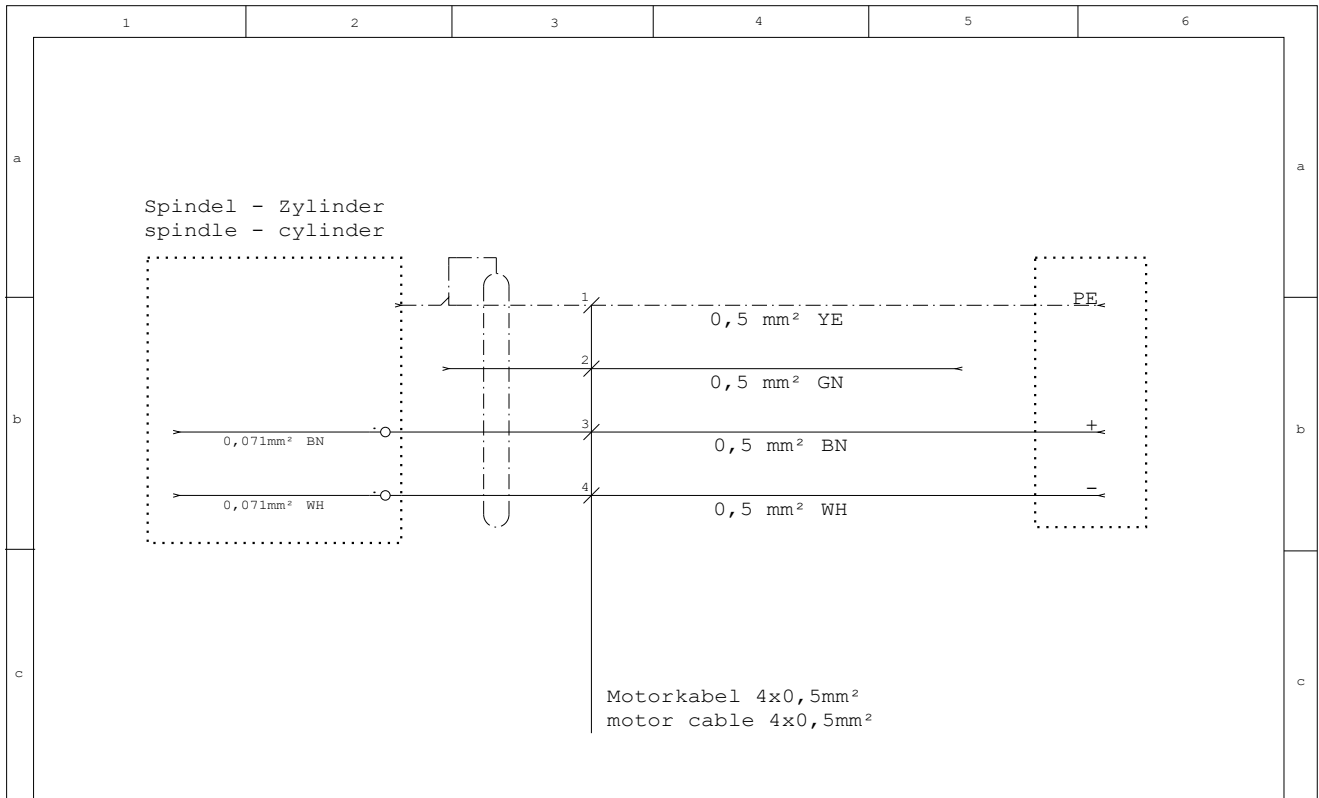

Nicht aufgelegte Adern absolieren und mit auf PE legen
 unutilised vein stripped and connected with protective earth

Funktionsbeschreibung wire specification			
Ader wire	Funktion function	Zyl. vor cyl. out	Zyl. zurück cyl. back
gelb yellow 0,5 mm ²	Schutzleiter protective earth		
braun brown 0,5 mm ²	Spannungsimpuls voltage impulse Versorgungsspannung supply voltage	+	-
weiß white 0,5 mm ²	Spannungsimpuls voltage impulse Versorgungsspannung supply voltage	-	+

* Pulsdauer max. 1sek.
 pulse-duration max. 1sec.

Datum	05.06.18		Zeichn.Nr.:	29043870	Projekt Nr.:	
Bearb.	Perschewski		Version Nr.:	2.0	Blatt 1	
Gepr.			Kabelanschlußplan elt. Zylinder		von 1	Bl.
Norm	DIN 81346					

Übersetzungen, Vervielfältigungen und die Weitergabe an Dritte, auch nur auszugsweise, ist ohne schriftliche Genehmigung der Fa. Nakanishi Jaeger GmbH untersagt

6.5

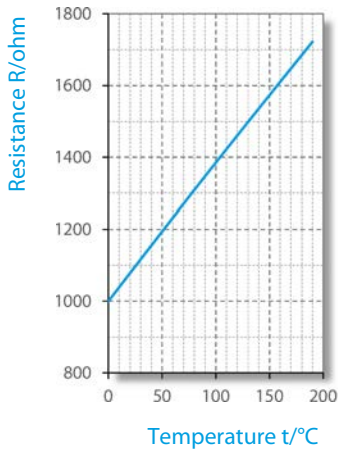
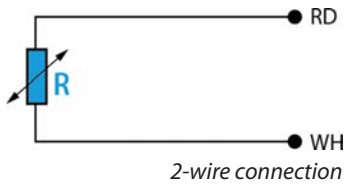

Motor protection Pt1000 (optional accessory)

Platinum temperature sensor

Design according to:

- DIN EN 60751
- Accuracy class B

Technical Specifications

Temperature/resistance correlation (series of basic values)

t ₉₀ /°C	(*) Resistance at temperature t ₉₀ /°C [Ω]									
	0	1	2	3	4	5	6	7	8	9
0	1000	1004	1008	1012	1016	1020	1023	1027	1031	1035
10	1039	1043	1047	1051	1055	1059	1062	1066	1070	1074
20	1078	1082	1086	1090	1094	1097	1101	1105	1109	1113
30	1117	1121	1125	1128	1132	1136	1140	1144	1148	1152
40	1155	1159	1163	1167	1171	1175	1179	1182	1186	1190
50	1194	1198	1202	1206	1209	1213	1217	1221	1225	1229
60	1232	1236	1240	1244	1248	1252	1255	1259	1263	1267
70	1271	1275	1278	1282	1286	1290	1294	1298	1301	1305
80	1309	1313	1317	1320	1324	1328	1332	1336	1340	1343
90	1347	1351	1355	1359	1362	1366	1370	1374	1378	1381
100	1385	1389	1393	1396	1400	1404	1408	1412	1415	1419
110	1423	1427	1431	1434	1438	1442	1446	1449	1453	1457
120	1461	1464	1468	1472	1476	1480	1483	1487	1491	1495
130	1498	1502	1506	1510	1513	1517	1521	1525	1528	1532
140	1536	1540	1543	1547	1551	1555	1558	1562	1566	1570
150	1573	1577	1581	1585	1588	1592	1596	1599	1603	1607
160	1611	1614	1618	1622	1625	1629	1633	1637	1640	1644
170	1648	1651	1655	1659	1663	1666	1670	1674	1677	1681
180	1685	1689	1692	1696	1700	1703	1707	1711	1714	1718

(*) Rounded values

6.6 Motor protection PTC 100°C (optional accessory)

PTC thermistor with protective insulation

Characteristic curves for rated response temperatures 90°C to 160°C in accordance with DIN VDE V 0898-1-401.

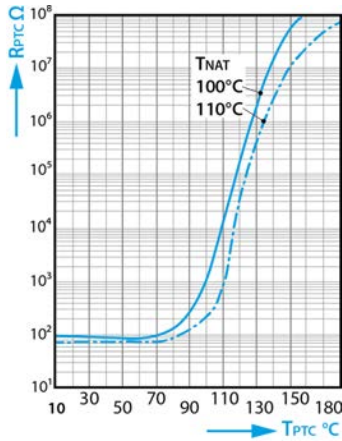

Positive temperature coefficient thermistor resistance (R_{PTC}) according to the positive temperature coefficient thermistor temperature (T_{PTC}) (small-signal resistance).

Technical Specifications

Type		M135	
Max. operating voltage	($T_A = 0 \dots 40^\circ\text{C}$)	V_{\max}	30 V
Max. measuring voltage	($T_A - 25 \text{ K} \dots T_{\text{NAT}} + 15 \text{ K}$)	$V_{\text{Meas,max}}$	7.5 V
Nominal resistance	($V_{\text{PTC}} \leq 2.5 \text{ V}$)	RN	$\leq 250 \Omega$
Insulation test voltage		V_{is}	3 kV~
Response time		t_a	< 2.5 s
Operating temperature range	($V=0$)	T_{op}	-25/+180°C

Resistance values

$T_{\text{NAT}} \pm \Delta T$	$R(T_{\text{NAT}} - \Delta T)$ ($V_{\text{PTC}} \leq 2.5 \text{ V}$)	$R(T_{\text{NAT}} - \Delta T)$ ($V_{\text{PTC}} \leq 2.5 \text{ V}$)	$R(T_{\text{NAT}} + 15 \text{ K})$ ($V_{\text{PTC}} \leq 7.5 \text{ V}$)	$R(T_{\text{NAT}} + 23 \text{ K})$ ($V_{\text{PTC}} \leq 2.5 \text{ V}$)
$100 \pm 5^\circ\text{C}$	$\leq 550 \Omega$	$\geq 1330 \Omega$	$\geq 4 \text{ k}\Omega$	----

6.7 ESD protection (optional accessory)

ESD protection is provided by creating an electrically conductive connection between the rotating shaft of the HF spindle and the motor housing.

- Depending on the operating time, the electrical resistance of this sliding contact is <1 kΩ.
- The wear on the sliding contact is not monitored.

6.8



Air-borne noise emissions

CAUTION: Noise has an impact on health.

▶ Only operate the HF spindle if you are wearing hearing protection.

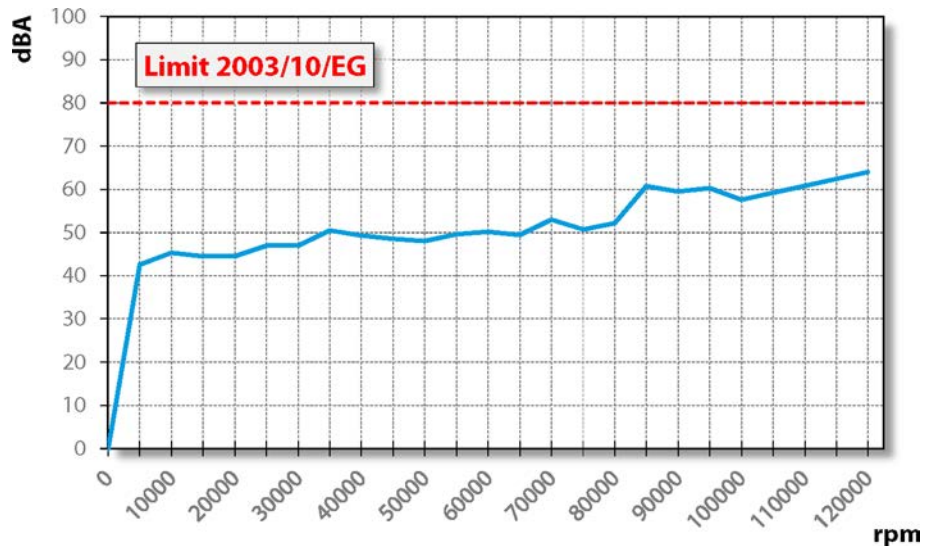

7



Operating location

DANGER: Due to flying parts.

If the HF spindle is incorrectly attached, it may come loose during operation and be flung away by the forces that occur.

▶ Clamp the HF spindle firmly.



WARNING: Risk of injury due to flying parts.

The HF spindle operates at high speeds which may cause chips to fly out with great force.

- ▶ Never remove the protective devices of the machine or system.
- ▶ Always wear protective goggles during work.

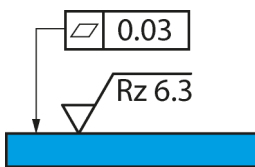

Example of design: Mounting surface

Note the following points before installing the HF spindle:

- ➡ Make sure that the correct spindle holder for the HF spindle is fitted in the machine.
- ➡ Check the connecting hoses for damage.
- ➡ Check the connecting cables for damage.
- ➡ Only use undamaged hoses and cables.
- ➡ Do not allow the HF spindle to run in the vicinity of a heat source.

8 Installation

Before installation:

- ➔ Check the HF spindle for damage and ensure that it is complete.

If the HF spindle has been stored for a long period:

- ➔ Carry out all steps in the Commissioning after storage section.

8.1 Installing the HF spindle

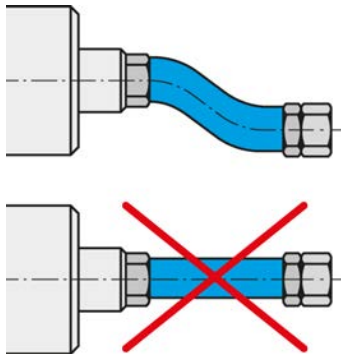

Connect media and cables with a flexible connection.

Complete the following steps in sequence to install the HF spindle:

- ➔ Remove the sealing plugs that protect the connections against damage and contamination during transportation.
- ➔ Instead of these sealing plugs, install the appropriate hose fittings.
- ➔ Install the corresponding hoses in the hose fittings
- ➔ Make sure that the connections are flexible and free of strain.
- ➔ Seal all connections for compressed air axially in relation to the tightening direction.
- ➔ If the HF spindle is equipped with sealing air:
 - ↻ Make sure that no air flow can occur in the bearing area.
 - ↻ Always use sealed cable boxes when connecting electrical lines.
- ➔ Mount the HF spindle on the machine.
- ➔ Connect the hoses to the connection of the respective media.
- ➔ Remove the protective cap that protects the shaft against damage and contamination during transportation.
- ➔ Connect the connector of the operating connection lines to the relevant connection of the HF spindle and to the frequency converter.
- ➔ Lock the connectors.

8.2 Diameter of media supply line

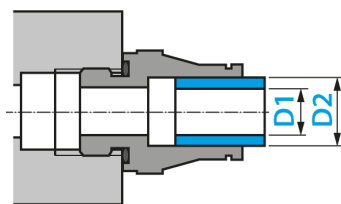

- ➔ The nominal size of the media supply lines can be found in the following table:

DN	Medium	D1		D2	
2.8	Compressed air	2.8 mm	$\frac{7}{64}$ "	4 mm	$\frac{5}{32}$ "
4	Compressed air	4 mm	$\frac{5}{32}$ "	6 mm	$\frac{15}{64}$ "
6	Compressed air	6 mm	$\frac{15}{64}$ "	8 mm	$\frac{5}{16}$ "

8.3 Compressed air

8.3.1 Air purity classes (ISO 8573-1)

Solid impurities	Class 3 Filter grade at least 5 µm for solids
Water content	Class 4 Max. pressure dew point +3 °C
Total oil content	Class 3 Max. oil content 1 mg/m ³

8.3.2 Setting the sealing air

For guidelines on air quality, see "Air purity classes (ISO 8573-1) [▶ 32]" section.

The adjustment value for the sealing air depends on the hose diameter and length.

- ➔ Hose diameter: DN 4
- ➔ The setting value can be found in the following diagram.
- ➔ To ensure effective control, turn on the sealing air and cooling when turning on the machine. This protects the HF spindle even when it is stationary.

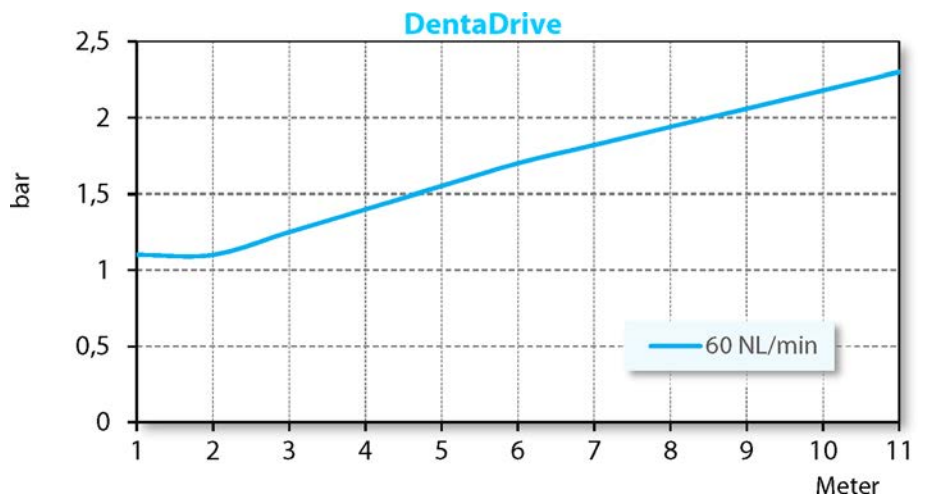

Note: Ensure functionality.

The HF spindle is cooled by the sealing air flowing through.

- Always switch on the sealing air as soon as the machine enters operation.
- Sealing air temperature: max. 25°C.

If this is not observed, the HF spindle will be damaged or destroyed.

8.3.3

For guidelines on air quality, see "Air purity classes (ISO 8573-1) [▶ 32]" section.



Setting values

➔ Keep to the following values:

Taper cleaning

0,5 - 2,5 bar

Note: Ensure functionality.

- Only switch on taper cleaning in conjunction with electromagnetic tool change.

If this is not done, the HF spindle will be damaged or destroyed.

9



Example of design: Inserting the shank

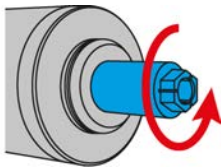

Example of design: Clockwise

9.1

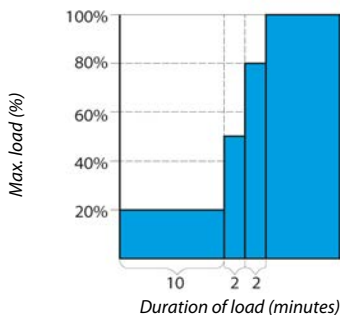

Commissioning

DANGER: Due to flying parts.

If the speed is selected incorrectly, the HF spindle or the tool may be destroyed and their fragments may be flung out.

- ▶ Note the maximum speed for the selected tool.
- ▶ Note the maximum speed for the HF spindle.
- ▶ The maximum permissible speed of the HF spindle for commissioning / processing is always the **lowest** specified speed.

Note: Ensure functionality.

- ▶ Never operate the HF spindle without a clamped tool shank.

If no tool shank is clamped:

- The clamping system is damaged by the centrifugal forces.
- The clamping system is shifted.
- The balance of the HF spindle is affected.
- The bearing is damaged.

- ➡ Turn the shaft of the spindle at least ten times by hand.

Running-in schedule

- ➡ Put the HF spindle into operation with a clamped tool (without machining) for approx. 10 minutes.
- ➡ The speed in this case should be no more than 20% of the maximum permissible speed for the HF spindle.
 - ↪ See definition: Max. permissible speed
- ➡ Allow the HF spindle to run for approx. 2 minutes at a maximum of 50% of the maximum permissible speed.
- ➡ Operate the HF spindle for approx. 2 more minutes at a maximum of 80% of the maximum permissible speed.

The HF spindle is now ready for operation.

9.2 Daily start-up

Proceed as follows to preheat the grease lubrication of the bearing and to protect it:

- ➔ Operate the HF spindle with a clamped tool (without machining).
 - ⚡ Approx. 2 minutes.
 - ⚡ At maximum 50 % of the maximum permissible speed.
(See Commissioning [▶ 34] section)

This brings the HF spindle to its operating temperature.

9.3 Shutdown signal

Use the option on the frequency converter of detecting the shutdown signal from the shaft and forwarding this to the machine controller for evaluation.

9.4 Commissioning after storage

- ➔ Do not put the HF spindle into operation until its temperature has adjusted from the temperature of the storage location to the temperature of the usage location.
 - ⚡ The temperature difference between the HF spindle and the usage location should not exceed 10°C.
- ➔ Carry out all steps in the "Maintenance [▶ 41]" section.
- ➔ Operate the HF spindle at a maximum of 50 % of the max. permissible speed for approx. 5 minutes.
 - ⚡ See Commissioning [▶ 34] section
- ➔ Operate the HF spindle for approx. 2 more minutes at a maximum of 80 % of the maximum permissible speed.

This preheats the grease lubrication of the bearing and protects it.

10

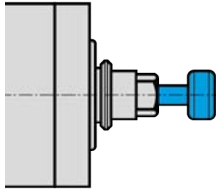

Example of design: Inserting the shank

10.1

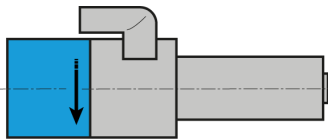

Sample illustration:
Direction of rotation indication

10.2

Tool change

CAUTION: Danger of being drawn in by rotating shaft.

If the shaft is still rotating, fingers and hands may be drawn in and crushed.

- ▶ Only change the tool if the shaft is at a standstill.

Note: Ensure functionality.

- ▶ Never operate the HF spindle without a clamped tool shank.

If no tool shank is clamped:

- The clamping system is damaged by the centrifugal forces.
- The clamping system is shifted.
- The balance of the HF spindle is affected.
- The bearing is damaged.

Clockwise

The HF spindle clamping system is designed for clockwise rotation.

- ↻ Only use tools with the correct direction of rotation for the HF spindle.
- ↻ Only use tool mounts with the correct HF spindle direction of rotation.
- ↻ Set the direction of rotation of the HF spindle on the FC in accordance with the arrow display on the HF spindle.

Electric Direct Tool Change

Note: Ensure functionality.

If the electromagnetic cylinder is supplied with current for too long it can overheat. The HF spindle and supply unit of the controller can be destroyed by this.

- ▶ Observe the maximum pulse duration of 0.2 seconds.
- ▶ Perform a maximum of 5 tool changes per minute.

Tip: Ensure concentric run-out quality.

- ▶ Keep collet, clamping nut, contact surface, shaft, tool taper, and tool mount clean at all times.
- ▶ When transporting the HF spindle, always fit an appropriate shank in the collet.

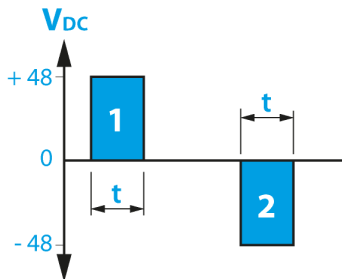

Sample illustration: Pulse duration

Note: Ensure functionality.

- Only switch on taper cleaning in conjunction with electromagnetic tool change.

If this is not done, the HF spindle will be damaged or destroyed.

	Tool	Pulse duration [t]
1	Cylinder forward	ejected
2	Cylinder back	clamped

(*) Other values by consultation.

- ➔ Make sure that the shaft of the HF spindle has come to an absolute standstill.
- ➔ Activate the electromagnetic tool change.
 - ↪ Cylinder forward.
- ➔ Remove the tool.
- ➔ Clean the inner taper of the tool mount and the inner taper of the shaft with the felt cleaning taper.
- ➔ Insert the tool.
- ➔ Activate the electromagnetic tool change.
 - ↪ Cylinder back.

The HF spindle is now ready for operation.

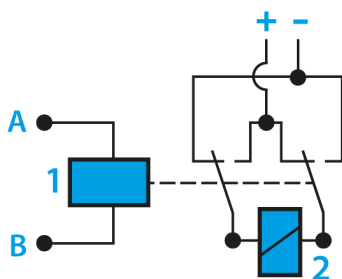
10.2.1**Connection example**

- | | |
|---|---------------|
| 1 | Relay |
| 2 | Electromagnet |

Tool is released/clamped via pole changing.

- ➔ Program the PLC of the machine tool accordingly.
- ➔ Alternatively:
 - ↪ Use relay with 2 changeover contacts.

10.2.2 Changing the collet

Proceed as follows to change the collet:

- ➔ Activate the electromagnetic tool change.
 - ↻ Cylinder forward.
- ➔ Remove the tool.



Note: Ensure functionality.

- ▶ Never close the collet without a clamped tool shank.

If no tool shank is clamped:

- The clamping system is damaged.

- ➔ Insert a suitable tool shank into the collet.
- ➔ Screw the collet out of the shaft of the HF spindle using the screw-in tool.

Tip: Ensure concentric run-out quality.

- ▶ Make sure that there is no contamination in the collet and that no contamination occurs during cleaning.

- ➔ Clean the inner taper of the shaft with the felt cone from the service set.
- ➔ Clean the collet with the brush.
- ➔ Apply a light greasy film to the taper of the collet. To do this, only use the collet grease from the service set.
- ➔ Insert a suitable tool shank into the collet.
- ➔ Screw the collet as far as possible into the shaft using the screw-in tool.
 - ↻ Tightening torque M_A max.: 0.5 Nm
- ➔ Activate the electromagnetic tool change.
 - ↻ Cylinder back.

Tip: Check the tool change.

- ▶ Activate the tool change 2-3 times.

- ➔ Check the fit of the collet.
 - ↻ Tighten the collet if necessary.
- ➔ Activate the electromagnetic tool change.
 - ↻ Cylinder forward.
- ➔ Remove the shank from the collet.
- ➔ Insert the tool.
- ➔ Activate the electromagnetic tool change.
 - ↻ Cylinder back.

The HF spindle is now ready for operation.

10.3

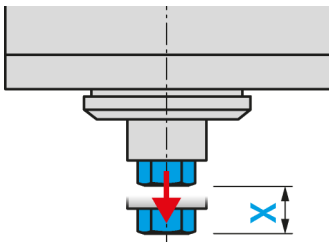

Example of design: Ejection travel

Tool changing station (optional accessory)

During a tool change, the HF spindle moves into the changing station with the clamped tool.

- Note the following values when producing the changing station in order to compensate for the ejection travel (X):

Spring loaded	X = 2 - 5 mm
Spring force	40 - 80 N

10.3.1

Electric Direct Tool Change

The HF spindle enters the changing station as far as the stop ring. Only then does the cylinder push the collet out of the shaft.

- The collet opens.
- Only the tool is deposited in the changing station.

Tip: Fast tool change.

- ▶ Use a tool with a stop ring.

This means that there is no need to re-adjust the immersion depth after each tool change.

10.3.2

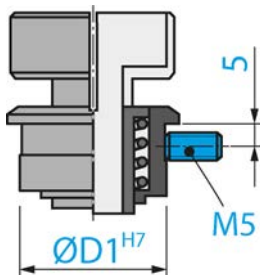

Installing the changing station

Proceed as follows to install the changing station:

- Drill a hole with a suitable diameter (Ø D1 H7) for the tool mount.
- Add an M5 thread.
- Insert the changing station into the hole.
- Secure the changing station using the threaded spindle (M5).

10.3.3

Maintenance

Before commencing work:

- Check that all surfaces are thoroughly cleaned and free of dust, grease, coolant, machining residues, and metal particles.
- Check that the changing station is free of damage.

11



Tools for high speed cutting

DANGER: Due to flying parts.

If the wrong direction of rotation is used, the tool is damaged when load is applied. The centrifugal forces cause the broken part to be flung out.

- ▶ Only use tools with the correct direction of rotation for the HF spindle.

DANGER: Due to flying parts.

If the speed is selected incorrectly, the HF spindle or the tool may be destroyed and their fragments may be flung out.

- ▶ Note the maximum speed for the selected tool.
- ▶ Note the maximum speed for the HF spindle.
- ▶ The maximum permissible speed of the HF spindle for commissioning / processing is always the **lowest** specified speed.

- ➔ Only use tools that are technically sound.
- ➔ Only use tools with a tool shank diameter that corresponds to the inner diameter of the collet. For example, do not use shanks with a diameter of 3 mm in collets for 1/8" (=3.175 mm).
 - ↳ Also see the Technical Specifications [▶ 16] section
- ➔ Only use tool shanks with a diameter tolerance of h6.
- ➔ Do not use tool shanks with a clamping surface (e.g. Weldon).
- ➔ Only use a balanced tool.
 - ↳ DIN ISO 1940, balance grade 2,5 .

11.1



Broken-off tool

CAUTION: Risk of burns.

The broken-off tool may be hot.

- ▶ Use gloves to protect against injury.

Remove the remains of the broken-off tool from the collet using the ejector pin from the service set.

Proceed as follows:

- ➔ Remove the collet from the shaft of the HF spindle.

Inside the collet there is a stop screw with a hole.

- ➔ Insert the ejector pin through this hole.
- ➔ Push the broken-off tool forward out of the collet using the ejector pin.
- ➔ Clean the collet.
- ➔ Insert the collet back into the HF spindle shaft.

12 Maintenance

Only specialist personnel may perform maintenance on the spindle.

The HF spindle must be shut down before any maintenance work.

- Make sure that the shaft of the HF spindle has come to an absolute standstill.
- Before carrying out any work, read the corresponding section of the manual carefully again.
- Observe the manual of the machine in which the HF spindle is installed.
- Observe all safety instructions and safety rules.

12.1 Ball bearings



Note: Foreign matter reduces the service life.

The HF spindle bearings have lifetime grease lubrication. This means that they do not require maintenance.

- ▶ Do not lubricate the ball bearings.
- ▶ Do not apply grease, oil, or cleaning agents to the openings of the HF spindle.

12.2 Daily cleaning

To ensure that the HF spindle functions safely and accurately, all contact surfaces of the HF spindle, the mount for the HF spindle, the tool mount, and the tool holder must be clean.



Note: Foreign matter reduces the service life.

- ▶ Do not use compressed air to clean the HF spindle.
- ▶ Do not use ultrasonic cleaning on the HF spindle.
- ▶ Do not use steam jets to clean the HF spindle.

This could cause contamination to enter the bearing area.

12.2.1 Before commencing work

- Check that all surfaces are thoroughly cleaned and free of dust, grease, coolant, machining residues, and metal particles.
- Check that the HF spindle is free of damage.
- If the HF spindle is equipped with sealing air, always switch this on during cleaning.
- Only use a clean, soft cloth or a clean, soft brush for cleaning.

12.2.2 With every tool change

- Ensure that the tool mount and tool shank are clean.
 - ↳ Remove any soiling.

12.2.3 Every time the clamping device is changed

- ➔ Clean the inner taper of the HF spindle shaft. The inner taper must be free of chips and contamination.
- ➔ Clean the tool taper.
- ➔ Apply a light greasy film to the taper of the collet after cleaning.
 - ✎ Only use the collet grease from the service set.

This improves the sliding movement and increases the clamping force of the collet.

12.3 In the case of storage

If the HF spindle is not required for a prolonged period of time:

- ➔ Store the HF spindle in horizontal position.
- ➔ Store the HF spindle so that it is protected from moisture, dust, and other environmental influences.
- ➔ Note the following storage conditions.

Temperature of storage location	+10°C ... + 45° C
Relative humidity	< 50 %

12.4 Monthly maintenance

- ➔ Turn the shaft of the HF spindle at least ten times by hand every four weeks.

12.5 Long periods of storage

- ➔ Turn the shaft of the HF spindle at least ten times by hand every three months.
- ➔ Then put the HF spindle into operation with a tool inserted for approx. 10 minutes.
 - ✎ The speed should be no more than 20 % of the maximum permissible speed for the HF spindle. (See Commissioning [▶ 34] section)

12.6 Maximum storage time

The maximum storage time is 2 years.

- ➔ Make sure that all information in the "Long periods of storage [▶ 42]" section is adhered to. This is the only way in which to maintain the functionality of the HF spindle.

13 Dismantling

Proceed as follows to remove the HF spindle:

- ➔ Completely disconnect the power supply.
- ➔ Completely disconnect the media supply (air and liquid).
- ➔ Make sure that the shaft of the HF spindle has come to an absolute standstill.
- ➔ Remove all connections from the HF spindle.
- ➔ Remove the HF spindle from the machine.

13.1 Disposal and environmental protection



More than 90% of the materials used in the HF spindle can be recycled (aluminum, stainless steel, steel, copper, etc.)

The HF spindle may not be disposed of with normal domestic waste.

- ➔ Remove all non-recyclable materials.
- ➔ Dispose of the HF spindle as scrap at an approved recycling facility.
- ➔ Follow all rules of the responsible administrative bodies.

If the HF spindle cannot be dismantled, send the HF spindle to **Nakanishi Jaeger GmbH**. **Nakanishi Jaeger GmbH** shall not assume the costs incurred for shipment and the fees for the recycling facilities.

14 Service and repairs



DANGER: Electric shock.

Electric shock can lead to severe burns and life-threatening injuries.

Take measures to prevent hazards caused by electrical energy (for details refer e.g. to the regulations issued by the VDE and the local energy supply companies).

- ▶ Before commencing work, switch off the power supply of the HF spindle.



Note: Damage due to electrostatic discharge.

Do not touch the electrostatic-sensitive components of the HF spindle.

14.1 Service partners

Only certified service partners may open and repair the spindle. Failure to comply with this voids any warranty claims and compensation claims for damages.

- ➔ The list of partners can be found on the following website.

<https://www.nakanishi-jaeger.com/en/contact/service-partners>

14.2

Malfunctions

The list below can be used to quickly investigate and eliminate faults.

HF spindle not rotating

Cause	Troubleshooting
No power supply	<ul style="list-style-type: none"> <input type="checkbox"/> Check the frequency converter. <input type="checkbox"/> Check the machine. <input type="checkbox"/> Check all electrical connections. <input type="checkbox"/> Check all wires in the motor cable. <input type="checkbox"/> Activate the Start/Reset button.
Thermal protection has been activated	<ul style="list-style-type: none"> <input type="checkbox"/> Wait until the HF spindle has cooled down. <input type="checkbox"/> Check the frequency converter for error messages. If no messages are illuminated, start the frequency converter. (See also "Spindle becomes hot [▶ 44]".)
Frequency converter has shut down	<ul style="list-style-type: none"> <input type="checkbox"/> Check the error messages in the frequency converter manual.
Tool change initiated	<ul style="list-style-type: none"> <input type="checkbox"/> Activate the electromagnetic tool change. (Cylinder back)

HF spindle becomes hot

Cause	Troubleshooting
Insufficient cooling	<ul style="list-style-type: none"> <input type="checkbox"/> Check the power of the chiller. <input type="checkbox"/> Check the water level of the chiller. <input type="checkbox"/> Check the connections and the cooling hoses. <input type="checkbox"/> Check the cooling circuit. <input type="checkbox"/> Check the chiller for error messages.
Phase missing	<ul style="list-style-type: none"> <input type="checkbox"/> Check all wires in the motor cable for cable breaks.
Machining too heavy	<ul style="list-style-type: none"> <input type="checkbox"/> Check the rotational direction of the HF spindle. <input type="checkbox"/> Check the rotational direction of the tool. <input type="checkbox"/> Check the tool for damage. <input type="checkbox"/> Reduce the machining load intensity.
Frequency converter incorrectly set	<ul style="list-style-type: none"> <input type="checkbox"/> Compare the values for the HF spindle with the set values on the frequency converter.

HF spindle becomes loud

Cause	Troubleshooting
Tool unsuitable	<ul style="list-style-type: none"> <input type="checkbox"/> Only use balanced tools. (Also see the "Tools for high speed cutting [▶ 40]" section.) <input type="checkbox"/> Check the tool for damage. <input type="checkbox"/> Replace damaged tool.
HF spindle is not clamped truly or is distorted	<ul style="list-style-type: none"> <input type="checkbox"/> Only use spindle holders from the original accessories or holders produced according to the tolerances specified by Nakanishi Jaeger GmbH.
HF spindle clamped too tightly	<ul style="list-style-type: none"> <input type="checkbox"/> Only tighten the clamping screws of the spindle holder manually. <input type="checkbox"/> Do not use technical aids to clamp the HF spindle.
Bearings damaged	<ul style="list-style-type: none"> <input type="checkbox"/> Contact Nakanishi Jaeger GmbH service.

No automatic tool change

Cause	Troubleshooting
Contamination	<ul style="list-style-type: none"> <input type="checkbox"/> Remove all contamination between the tool taper and shaft of the HF spindle. (Observe all points in the "Tool change [▶ 36]" and "Maintenance [▶ 41]" sections.)
Collet does not open	<ul style="list-style-type: none"> <input type="checkbox"/> Check the electrical connection of the cylinder. (Observe all points in the "Tool change [▶ 36]" and "Maintenance [▶ 41]" sections.)
Phase missing	<ul style="list-style-type: none"> <input type="checkbox"/> Check all wires in the motor cable for cable breaks.

Sensor does not send any signals

Cause	Troubleshooting
No connection to sensor	<ul style="list-style-type: none"> <input type="checkbox"/> Check the lines and connections.

**HF spindle vibrates/
oscillates**

Cause	Troubleshooting
Tool unsuitable	<ul style="list-style-type: none"> <input type="checkbox"/> Only use balanced tools. (Also see the "Tools for high speed cutting [▶ 40]" section.) <input type="checkbox"/> Check whether the tool is suitable for the application. <input type="checkbox"/> Check the tool for damage. <input type="checkbox"/> Replace damaged tool.
Contamination	<ul style="list-style-type: none"> <input type="checkbox"/> Remove all contamination between the tool taper and shaft of the HF spindle. (Observe all points in the "Tool change [▶ 36]" and "Maintenance [▶ 41]" sections.)
Frequency converter incorrectly set	<ul style="list-style-type: none"> <input type="checkbox"/> Compare the values for the HF spindle with the set values on the frequency converter.
Machining too heavy	<ul style="list-style-type: none"> <input type="checkbox"/> Reduce the machining load intensity.
Mounting screws are loose	<ul style="list-style-type: none"> <input type="checkbox"/> Tighten the screws securely.
HF spindle damaged	<ul style="list-style-type: none"> <input type="checkbox"/> Contact Nakanishi Jaeger GmbH service.

If the error is not rectified after checking all of the points, contact the relevant service partner.

- ➔ Request the accompanying note for the repair from the service partner.
- ➔ Check the manual of the machine.
- ➔ Contact the manufacturer of the machine.

15 Declaration of Incorporation

The safety instructions of the product documentation supplied must be observed.

Under the EC Machinery Directive

Nakanishi Jaeger GmbH

SF-Elektromaschinenbau

Siemensstr. 8

D-61239 Ober-Mörlen

Tel. +49 (0) 60029123 -0

hereby declare that the product,

Product	High Frequency Spindle
Type	DentaDrive 120V S21
Serial no.	See last page of manual

as far as possible from the supplied, complies with the essential requirements of the Machinery Directive 2006/42/EC.

Sections of the Machinery Directive have been applied: 1.1.1; 1.1.2; 1.1.5; 1.3.2; 1.3.4; 1.5.1; 1.5.2; 1.5.4; 1.5.5; 1.5.6; 1.5.8; 1.5.9; 1.6.4; 1.6.5; 1.7.1; 1.7.1.1; 1.7.2; 1.7.3; 1.7.4;

The incomplete machinery in its standard design complies furthermore with the following applicable regulations:

Applicable harmonized standards	DIN EN ISO 12100 Safety of machines
---------------------------------	----------------------------------------

The machinery is incomplete and must not be put into service until the machinery into which it is to be incorporated has been declared in conformity with the provisions of the Machinery Directive 2006/42/EC and any other applicable regulations.

We at Nakanishi Jaeger GmbH agree to submit the special documents for incomplete machines to national authorities upon request.

The special technical documentation referred to in Annex VII, Part B, belonging to the machine has been created.

Person who is authorized to compile the documents listed in Annex VII, Part B:

Nakanishi Jaeger GmbH

Ober-Mörlen, 01.09.2023



Nakanishi Jaeger YouTube channel

Scan this QR code with any QR code scanner.



Nakanishi Jaeger GmbH

Siemensstraße 8
61239 Ober-Mörlen
GERMANY

☎ +49 (0)6002-9123-0
✉ sales@anakanishi-jaeger.com
www.nakanishi-jaeger.com

Jaeger Spindles North America, Corp.

6611 Bay Circle, Suite 165
Norcross, GA 30071
USA

☎ +1 (770) 674-4480
✉ office@jaegerspindles.com
www.nakanishi-jaeger.com/en

Serial number

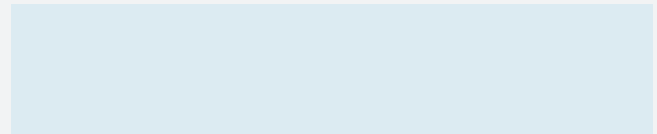

Type **DentaDrive 120V S21**

Item no. **153IG321**

Revision 02 Date 01.09.2023

Language EN

